

MADE IN ITALY  
SINCE 1920

 **Rinieri**



BRACCI DECESPUGLIATORI - BUSH CUTTER MACHINES  
BRAS DEBROUSSAILLEURS - BÖSCHUNGSMÄHER  
BRAZOS DESBROZADORES



[www.rinieri.com](http://www.rinieri.com)

# BRM 120





2 cm (0,8")





15 - 40



 Braccio potasiepi con barra falciante da 120cm per potatura di alberi e siepi Ø 2cm adatto anche a mini trattori. E' dotato di telaio reversibile con 3 movimenti idraulici e distributore indipendente.

 Hedge bush cutter with cutting bar cm 120 (4') to prune trees up to 2 cm (0,8") also suitable for mini tractors. It features reversible frame with 3 hydraulic movements and independent distributor.

 Bras taille-haies avec barre de coupe de 120 cm pour la taille des arbres et des haies Ø 2cm également adapté pour les mini tracteurs. Il dispose de châssis réversible avec 3 mouvements hydrauliques et distributeur indépendant.

 Heckenschneider mit Schneidebalken zu 120 cm, für das Schneiden von lebenden Umzäunungen, bis zu Ø 2cm ideal für Kleintraktoren. Der BRM 120 kann links oder rechts montiert werden und verfügt über einen Dreihebelsteuerblock.

 Brazo podador con barra cortante de 120 cm para podar árboles y setos de 2 cm de diámetro, adecuado también para mini tractores. Tiene chasis reversible con 3 movimientos hidráulicos y distribuidor independiente.

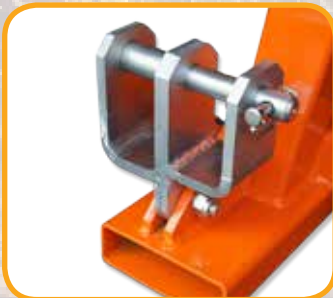

Snodo di sicurezza  
Safety brake away support  
Support de sécurité  
Sicherheitsgelenk  
Articulación de seguridad

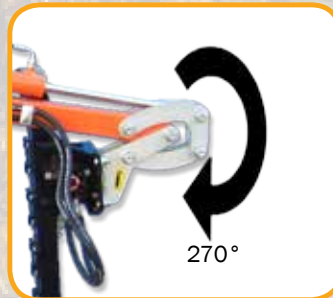

Snodo rotazione barra di taglio  
Tilting of the cutter bar  
Rotation de la barre de coupe  
Neigung des Scheidebalkens  
Articulación para rotación barra de corte





Comando standard  
Standard controls  
Commande standard  
Standardschaltung  
Comando estandar

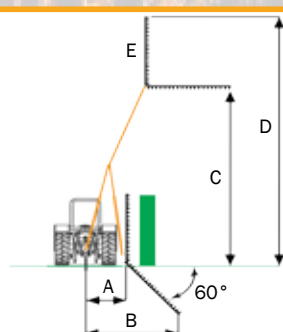

Joystick proporzionale (optional)  
Proportional joystick (optional)  
Joystick proportionnel (optionnel)  
Proportionaler Joystick (optional)  
Joystick proporcional (opcional)



MOD	A cm (inch)	B cm (inch)	C cm (inch)	D cm (inch)	E cm (inch)	 l/min (gpm)	 Kg (lbs)	 Kg (lbs)
BRM 120	100 (39)	170 (67)	260 (102)	410 (161)	120 (47)	12 (3,2)	180 (396)	500 (1100)

# BRM 150 - 200





3 cm (1,2")





25 - 50



 Bracci potasiepi con barra falciante da 150 e 200 cm per potatura di alberi e siepi Ø 3cm adatti anche a piccoli trattori. Sono dotati di telaio reversibile con 3 movimenti idraulici, distributore indipendente con cavi flessibili e di un sistema in grado di assicurare ogni angolo di taglio su entrambi i lati del trattore.

 Hedge bush cutters with cutting bar 150 and 200 cm (5' and 6,5') for pruning trees and hedges up to 3 cm (1,2") also suitable for small tractors. They are equipped with reversible frame with 3 hydraulic movements, independent distributor with flexible cables and a system capable of ensuring each cutting angle on both sides of the tractor.

 Bras taille-haies avec barre de coupe de 150 et 200 cm pour la taille des arbres et des haies Ø 3cm également adapté pour les petits tracteurs. Ils sont équipés de châssis réversible avec trois mouvements hydrauliques, distributeur indépendant avec des câbles flexibles et d'un système capable d'assurer chaque angle de coupe des deux côtés du tracteur.

 Heckenschneider mit Schneidebalken zu 150 und 200 cm, für das Schneiden von lebenden Umzäunungen bis zu Ø 3 cm, ideal auch für Kleintraktoren. Der BRM 150-200 kann links oder rechts montiert werden, um beidseitig arbeiten zu können und verfügt über einen Dreihebelsteuerblock, der am Gerät fixiert ist und über Bowdenzug bedient wird.

 Brazos podadores con barra cortante de 150 y 200 cm para podar árboles y setos de 3 cm de diámetro, adecuados también para pequeños tractores. Tienen chasis reversible con 3 movimientos hidráulicos, distribuidor independiente con cables flexibles y un sistema que permite cortar con cualquier capacidad angular sobre los dos lados del tractor.

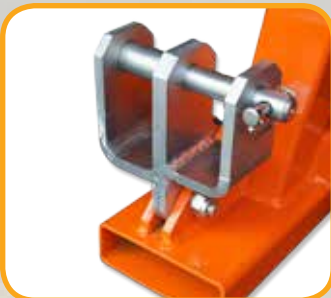

Snodo di sicurezza  
Safety brake away support  
Support de sécurité  
Sicherheitsgelenk  
Articulación de seguridad

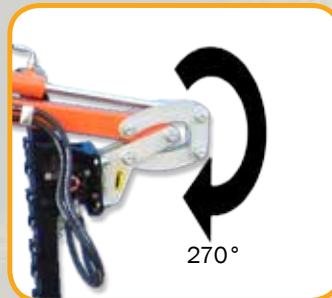

Snodo rotazione barra di taglio  
Tilting of the cutter bar  
Rotation de la barre de coupe  
Neigung des Schneidebalkens  
Articulación para rotación barra de corte





Comando standard  
Standard controls  
Commande standard  
Standardschaltung  
Comando estandar

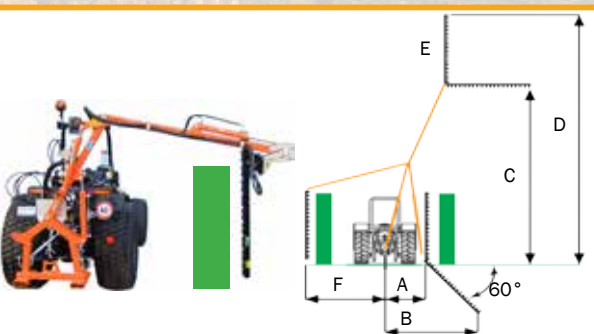

Joystick proporzionale (optional)  
Proportional joystick (optional)  
Joystick proportionel (optionnel)  
Proportionaler Joystick (optional)  
Joystick proporcional (optcional)



MOD	A cm (inch)	B cm (inch)	C cm (inch)	D cm (inch)	E cm (inch)	F cm (inch)	 l/min (gpm)	 Kg (lbs)	 Kg (lbs)
BRM 150	85 (33)	210 (83)	380 (150)	550 (217)	150 (59)	240 (94)	20 (5,3)	200 (440)	600 (1320)
BRM 200	85 (33)	240 (94)	380 (150)	600 (236)	200 (79)	240 (94)	25 (6,6)	220 (484)	700 (1540)



2 cm (0,8")



20 - 50



Bracci decespugliatori per trattori con piccole potenze 20-50 HP ideali per hobbisti e piccole aziende. Sono costruiti in 4 modelli con sbraio da 1,6 a 3,5m, già predisposti con attacchi doppi per trattori con sollevatori anteriori o trattori reversibili.

Hedge bush cutters for tractors with low power (20-50 HP) ideal for hobbyists and small businesses. They are manufactured in 4 models reaching from 1.6 to 3,5 m (5,25' to 11,5') already fitted with double hitches for tractors with front linkage or reversible tractors.

Bras taille- haies pour les tracteurs avec petites puissances 20-50HP idéales pour les amateurs et les petites entreprises. Ils sont disponibles en 4 modèles avec portée de 1,6 à 3,5 m, déjà équipé d'attaches doubles pour les tracteurs avec élévateurs antérieurs ou tracteurs réversibles.

Böschungsmäher für Traktoren mit einer Leistung um die 20-50 PS ideal für den Eigengebrauch. Vier Modelle stehen zur Verfügung mit Reichweiten von 1,6 bis 3,5 m, geeignet um front- oder heckseitig angebaut zu werden.

Brazos desbrozadores para tractores de poca potencia, 20-25 HP, ideales para aficionados y pequeñas empresas. Se construyen 4 modelos con despliegue de 1,6 a 3,5 m, ya dispuestos con doble enganche para tractores con elevador anterior o tractores reversibles.



Snodo meccanico di sicurezza  
Safety mechanic support  
Support de sécurité mécanique  
Mechanisches Sicherheitsgelenk  
Articulación mecánica de seguridad



Comando standard  
Standard controls  
Commande standard  
Standardschaltung  
Comando estandar



Joystick proporzionale (optional)  
Proportional joystick (optional)  
Joystick proportionel (optionnel)  
Proportionaler Joystick (optional)  
Joystick proporcional (opcional)



Trasmissione a cinghie (optional)  
Belt power drive (optional)  
Transmission par courroie (optionnel)  
Riemenantrieb (optional)  
Transmisión con correas (opcional)

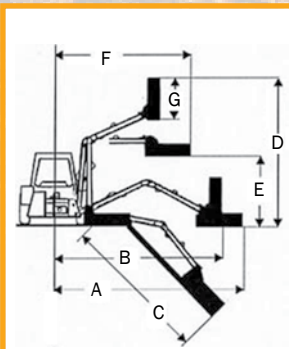

MOD	A cm (inch)	B cm (inch)	C cm (inch)	D cm (inch)	E cm (inch)	F cm (inch)	G cm (inch)	oil l (gal)	Kg (lbs)	Kg (lbs)
BRF 160	170 (67")	190 (75")	110 (43")	230 (91")	110 (43")	135 (53")	50 (20")	30 (8)	230 (506)	600 (1320)
BRF 250	250 (98")	240 (94")	200 (79")	280 (110")	160 (63")	170 (67")	60 (24")	48 (13)	260 (572)	700 (1540)
BRF 300	300 (118")	290 (114")	250 (98")	300 (118")	180 (71")	190 (75")	80 (31")	55 (15)	300 (660)	800 (1760)
BRF 350	350 (138")	340 (134")	300 (118")	350 (138")	200 (79")	210 (83")	80 (31")	55 (15)	350 (770)	900 (1980)



3 cm (1,2")



50 - 70



Bracci decespugliatori per trattori con medie potenze da 50-70 HP ideali per piccole e medie aziende. Sono costruiti in 2 modelli con sbarraccio da 4 a 4,5 m e testata di lavoro da 1m.

Hedge bush cutters for medium power tractors with 50-70 HP ideal for small and medium businesses. They are available in 2 models reaching from 4 to 4,5 m (13' to 15') and equipped with a 1m working head.

Bras taille-haies pour tracteurs avec une puissance moyenne de 50-70 HP Idéal pour les petites et moyennes entreprises. Ils sont disponibles en 2 modèles avec portée de 4 à 4,5 m et tête de travail de 1m.

Böschungsmäher für Traktoren mit einer Leistung um die 50-70 PS ideal für mittlere Betriebsgrößen. Zwei Modelle stehen zur Verfügung mit Reichweiten von 4,0 bis 4,5 m, Mulchkopf zu 1m.

Brazos desbrozadores para tractores de mediana potencia, 50-70 HP, ideales para pequeñas y medianas empresas. Se construyen 2 modelos con despliegue de 4 a 4,5 m y cabecera de 1 m.



Snodo meccanico di sicurezza  
Safety machanic support  
Support de sécurité mécanique  
mechanisches Sicherheitsgelenk  
Articulación mecanica de seguridad



Comando standard  
Standard controls  
Commande standard  
Standardschaltung  
Comando estandar



Trasmissione a cinghie (optional)  
Belt power drive (optional)  
Transmission par courroie (optionnel)  
Riemenantrieb (optional)  
Transmisión con correas (optcional)



Joystick proporzionale (optional)  
Proportional joystick (optional)  
Joystick propotionel (optionnel)  
Proportionaler Joystick (optional)  
Joystick proporcional (optcional)

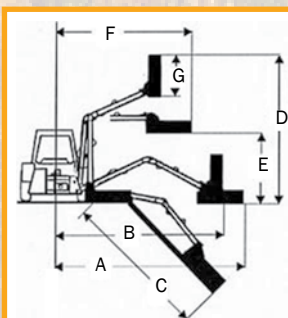

MOD	A cm (inch)	B cm (inch)	C cm (inch)	D cm (inch)	E cm (inch)	F cm (inch)	G cm (inch)	oil l (gal)	Kg (lbs)	Kg (lbs)
BRV 400	420 (165")	340 (134")	330 (130")	480 (189")	260 (102")	230 (91")	100 (39")	85 (22)	530 (1166)	2100 (4620)
BRV 450	470 (185")	390 (154")	350 (138")	500 (197")	310 (122")	250 (98")	100 (39")	85 (22)	570 (1254)	2200 (4840)



3 cm (1,2")



50 - 70



Braccio decespugliatore dalla particolare geometria in grado di superare e lavorare oltre ostacoli come siepi, reti o filari. Il braccio su cui è montata la testata di lavoro è telescopico in modo da adattarsi meglio ai dislivelli del terreno.

Hedge bush cutter manufactured with a particular geometrical shape able to overcome and work over obstacles such as bushes, nets or rows. The arm on which is mounted the working head is telescopic to adapt better to the unevenness of the ground.

Bras taille-haies avec une géométrie particulière qui peut surmonter et travailler sur des obstacles tels que des haies, des filets ou des rangées. Le bras sur lequel est montée la tête de travail est télescopique afin de mieux s'adapter aux inégalités du sol.

Böschungsmäher für die Arbeit über Hindernissen. Der Arm ist teleskopisch ausfahrbar, um sich zusätzlich besser an die Unebenheiten des Bodens anzupassen.

Brazo desbrozador con una geometría especial que permite superar y trabajar mas allá de obstáculos como setos, redes e hileras. El brazo sobre el que se monta la cabecera es telescópico y de esta manera puede adaptarse mejor a los desniveles del terreno.



Snodo idraulico di sicurezza  
Hydraulic Safety brake away  
Articulation hydraulique de sécurité  
Hydraulisches Sicherheitsgelenk  
Articulación hidraulica de seguridad



Braccio telescopico  
Telescopic arm  
Bras télescopique  
Teleskoparm  
Brazo telescopico



Posizione per il trasporto  
Transport position  
Position pour le transport  
Position für den Transport  
Posición para el transporte



Comando standard a leva o joystick  
Standard controls with lever or optional joystick  
Commande standard avec levier ou joystick optionnel  
Standardschaltung mit Hebel oder auf Bestellung mit Joystick  
Comando estandar o joystick

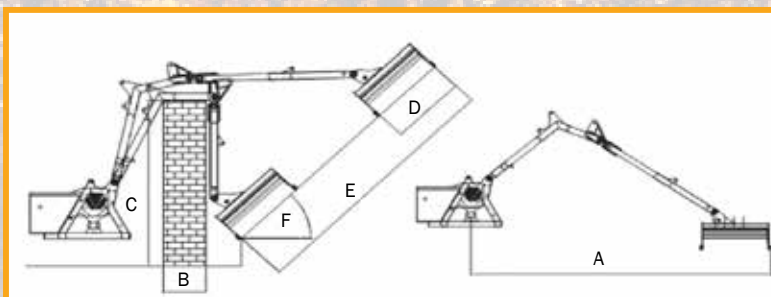

MOD	A cm (inch)	B cm (inch)	C cm (inch)	oil 	 Kg (lbs)	 Kg (lbs)
BR VIGNA	420 (165")	60 (24")	220 (87")	95 (25)	530 (1166)	2200 (4840)
	D cm (inch)	E cm (inch)	F cm (inch)			
	80 (31")	320 (126")	45°			



6 cm (2,4")



60 - 90



Bracci decespugliatori per trattori con medie potenze 60-90 HP. Sono costruiti in 3 modelli con sbraccio da 4,5 a 5,3 m. Adatti ad uso professionale e grandi aziende grazie all'adozione del gruppo pompe e motore GR.3 e radiatore per l'olio. A richiesta è disponibile la versione con rotazione di 90° del primo braccio per il rientro in sagoma (**Mod. BRC-S**).

Hedge bush cutters for tractors with medium power 60-90 HP. They are manufactured in 3 models reaching from 4.5 to 5.3 m (15' to 17'). Suitable for professional use and big businesses thanks to the adoption of pumps and motor GR.3 and oil cooler.

Bras taille-haies pour les tracteurs avec moyenne puissance 60-90HP. Ils sont disponibles en 3 modèles avec portée de 4,5 à 5,3 m. Conseillés pour une utilisation professionnelle et des grandes entreprises grâce à l'adoption des pompes, du moteur GR.3 et refroidisseur d'huile.

Böschungsmäher für Traktoren mit einer Leistung um die 60-90 PS. Drei Modelle stehen zur Verfügung mit Reichweiten von 4,5 bis 5,3 m. Ideal für Großbetriebe oder Lohnarbeit, dank auch der Verwendung der GR. 3 Pumpen-Gruppe und Motoren und serienmäßig montiertem jk Ölkühler.

Brazos desbrozadores para tractores de mediana potencia, 60-90 HP. Se construyen 3 modelos con despliegue de 4,5 a 5,3 m. Adecuados para uso profesional y para grandes empresas gracias al grupo de bombas y motor GR.3 y al radiador para el aceite.



Snodo idraulico di sicurezza  
Hydraulic Safety brake away  
Articulation hydraulique de sécurité  
Hydraulisches Sicherheitsgelenk  
Articulación hidráulica de seguridad



Radiatore  
Oilcooler  
Radiateur  
Ölkühler  
Radiador



Pompe GR.3  
Pumps GR.3  
Pompes GR.3  
Pumpe GR.3  
Bombas GR.3



Comando standard o joystick  
Standard controls or joystick  
Commande standard ou joystick  
Standardschaltung oder Joystick  
Comando estandar o joystick

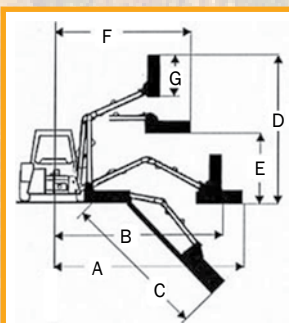

MOD	A cm (inch)	B cm (inch)	C cm (inch)	D cm (inch)	E cm (inch)	F cm (inch)	G cm (inch)	oil l (gal)	Kg (lbs)	Kg (lbs)
BRC 450	450 (177")	380 (150")	350 (138")	390 (154")	240 (94")	240 (94")	100 (39")	190 (50)	820 (1804)	2500 (5500)
BRC 485	485 (191")	415 (163")	385 (152")	425 (167")	250 (98")	245 (96")	100 (39")	200 (53)	850 (1870)	2800 (6160)
BRC 530	530 (209")	460 (181")	430 (169")	470 (185")	265 (104")	260 (102")	100 (39")	200 (53)	870 (1914)	3200 (7040)



6 cm (2,4")



80 - 110



Bracci decespugliatori con caratteristiche professionali per trattori con alte potenze 80-110 HP. Sono costruiti in 2 misure di sbraccio da 5 a 6 m. La rotazione posteriore del braccio riporta in sagoma la macchina per la circolazione stradale.

Hedge bush cutters with professional features for tractors with high power 80-110 HP. They are manufactured in 2 reach sizes from 5 to 6 m (16' to 20'). The rear rotation of the arm pushes the machine back to the tractor for the road traffic.

Bras taille-haies avec des fonctionnalités professionnelles pour les tracteurs avec une grande puissance 80-110 HP. Ils sont disponibles en 2 tailles pour atteindre de 5 à 6 m. La rotation postérieure du bras remet en forme la machine pour la route.

Professioneller Böschungsmäher für Traktoren mit einer Leistung um die 80-110 PS. Zwei Modelle stehen zur Verfügung mit Reichweiten von 5 bis 6 m. Die Drehung des Armes nach hinten, geht bis auf 90 Grad.

Brazos desbrozadores con características profesionales para tractores de elevada potencia, 80-110 HP. Se construyen con 2 medidas de despliegue de 5 a 6 m. La rotación posterior del brazo le permite recogerse para poder circular por carretera.



Snodo idraulico di sicurezza e rotazione a 90°  
Hydraulic safety rotation 90°  
Articulation hydraulique de sécurité avec rotation 90°  
Hydraulisches Sicherheitsgelenk mit 90° Drehung  
Articulación hidraulica de seguridad y rotación 90°



Radiatore  
Oilcooler  
Radiateur  
Ölkühler  
Radiador



Pompe GR.3  
Pumps GR.3  
Pompes GR.3  
Pumpe GR.3  
Bombas GR.3



Comando standard a leva o joystick  
Standard controls with lever or optional joystick  
Commande standard avec levier ou joystick optionnel  
Standardschaltung mit Hebel oder auf Bestellung mit Joystick  
Comando estandar o joystick

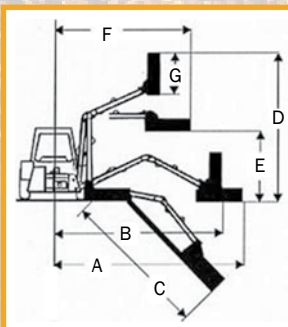

MOD	A cm (inch)	B cm (inch)	C cm (inch)	D cm (inch)	E cm (inch)	F cm (inch)	G cm (inch)	oil I (gal)	Kg (lbs)	Kg (lbs)
BRL 500	510 (201")	450 (177")	420 (165")	470 (185")	240 (94")	300 (118")	100 (39")	200 (53)	990 (2178)	3700 (8140)
BRL 600	620 (244")	530 (209")	520 (205")	570 (224")	255 (100")	390 (154")	120 (47")	205 (54)	1060 (2332)	4300 (9460)





6 cm (2,4")



100 - 120



**IT** Braccio decespugliatore con caratteristiche professionali per trattori con alte potenze 100-120HP, costruito in una misura di sbraccio 6,6m. Si differenzia dal modello BRL per l'adozione di un braccio telescopico idraulico che ne migliora notevolmente la manovrabilità.

**UK** Hedge bush cutter with professional features for tractors with high power 100-120 HP, manufactured with 6,6 m (22') reach length. It differs from BRL model as it has an hydraulic telescopic arm which considerably improves maneuverability.

**FR** Bras taille-haies avec des fonctionnalités professionnelles pour les tracteurs de grande puissance 100-120 HP, disponible en une seule dimension pour rejoindre jusqu'à 6,6 m. Il diffère du modèle BRL pour l'adoption d'un bras télescopique hydraulique qui améliore notablement la manoeuvrabilité.

**DE** Professioneller Böschungsmäher für Traktoren mit einer Leistung um die 90-110 PS. Reicht bis zu 6,6 m und unterscheidet sich zu den anderen durch seinem Teleskoparm, der die Manövrierfähigkeit erheblich verbessert.

**ES** Brazo desbrozador con características profesionales para tractores de elevada potencia, 100-120 HP, se construye con una medida de despliegue de 6,6 m. Se diferencia del modelo BRL por el brazo telescópico hidráulico que mejora notablemente la facilidad de maniobra.



Snodo idraulico di sicurezza e rotazione a 90°  
Hydraulic safety rotation 90°  
Articulation hydraulique de sécurité avec rotation 90°  
Hydraulisches Sicherheitsgelenk mit 90° Drehung  
Articulación hidraulica de seguridad y rotación 90°



Braccio telescopico  
Telescopic arm  
Bras télescopique  
Teleskoparm  
Brazo telescopico



Pompe GR.3 in ghisa e radiatore  
Pumps GR.3 in cast iron and oilcooler  
Pompes GR.3 en fonte et radiateur  
Pumpe GR.3 in Gusseisen und Ölkühler  
Bombas GR.3 de hierro fundido y radiador



Comando standard a leva o joystick  
Standard controls with lever or optional joystick  
Commande standard avec levier ou joystick optionnel  
Standardschaltung mit Hebel oder auf Bestellung mit Joystick  
Comando estandar o joystick

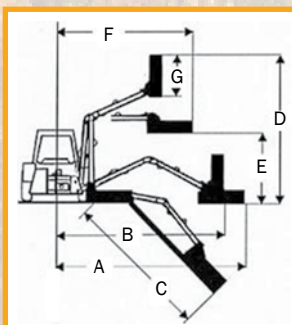

MOD	A cm (inch)	B cm (inch)	C cm (inch)	D cm (inch)	E cm (inch)	F cm (inch)	G cm (inch)	oil l (gal)	Kg (lbs)	Kg (lbs)
BRT 660	660 (260")	590 (232")	570 (224")	660 (260")	255 (100")	410 (161")	120 (47")	210 (55)	1220 (2684)	5000 (11000)



6 cm (2,4")



130 - 170



**Italian:** Braccio decespugliatore con sistema di avanzamento idraulico della testata che ne migliora la visibilità e la facilità di uso. È adatto ai professionisti più esigenti e viene abbinato a trattori con minimo 130 HP.

**English:** Hedge bush cutter with hydraulic feed system of the head which improves the visibility and easeness of the use. It is suitable for the most demanding professionals and is combined with tractors with a minimum of 130 HP.

**French:** Bras taille-haies avec le système d'avancement hydraulique de la tête qui améliore la visibilité et la facilité d'utilisation. Machine conseillé pour les professionnels les plus exigeants et qui est associé à des tracteurs avec un puissance minimale de 130 HP.

**German:** Für Traktoren mit einer Leistung von über 130 PS. Vorteilhaft ist die Möglichkeit den Mulchkopf auf Fahrerhöhe zu führen, was im dauerhaftem Einsatz von entscheidenden Vorteil ist.

**Spanish:** Brazo desbrozador con sistema de avance hidráulico de la cabecera que mejora la visibilidad y la facilidad de manejo. Es adecuado para los profesionales más exigentes y se acopla a tractores con una potencia mínima de 130HP.



Snodo idraulico di sicurezza e rotazione a 90°  
Hydraulic safety rotation 90°  
Articulation hydraulique de sécurité avec rotation 90°  
Hydraulisches Sicherheitsgelenk mit 90° Drehung  
Articulación hidraulica de seguridad y rotación 90°



Pompe GR.3 in ghisa e radiatore  
Pumps GR.3 in cast iron and oilcooler  
Pompes GR.3 en fonte et radiateur  
Pumpe GR.3 in Gusseisen und Ölkühler  
Bombas GR.3 de hierro fundido y radiador



Posizione per il trasporto  
Transport position  
Position pour le transport  
Position für den Transport  
Posición para el transporte



Comando standard a leva o joystick  
Standard controls with lever or optional joystick  
Commande standard avec levier ou joystick optionnel  
Standardschaltung mit Hebel oder auf Bestellung mit Joystick  
Comando estandar o joystick

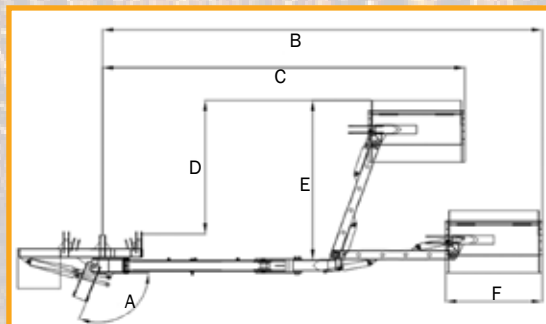

MOD	A	B cm (inch)	C cm (inch)	D cm (inch)	E cm (inch)	F cm (inch)	oil l (gal)	Kg (lbs)	Kg (lbs)
BR VISION	112°	620 (244")	510 (201")	245 (96")	280 (110")	120 (47")	170 (45)	1680 (3696)	6000 (13200)

# OPTIONAL

MOD		TESTATA (IMG) cm (inch)			MOD	
	cm (inch)		Kg (lbs)	n°		
	BT 120/02	2 (0,8")	120 (47")	45 (99)	-	BRF - BRV
	BT 150/03	3 (1,2")	150 (59")	50 (110)	-	BRF - BRV
	BT 180/03	3 (1,2")	180 (71")	55 (121)	-	BRF - BRV
	BT 200/03	3 (1,2")	200 (79")	60 (132)	-	BRF - BRV
	BT 150/05	5 (2")	150 (59")	145 (320)	-	BRC
	BT 180/05	5 (2")	180 (71")	155 (342)	-	BRC
	BT 210/05	5 (2")	210 (83")	170 (375)	-	BRC
	BT 150/10	10 (3,9")	150 (59")	215 (474)	-	BRL - BRT
	BT 190/10	10 (3,9")	190 (75")	235 (518)	-	BRL - BRT
	BT 220/10	10 (3,9")	220 (87")	250 (551)	-	BRL - BRT
	TDL 100	6	100 (39")	40 (88)	3	BRV
	TDL 140	6	140 (55")	50 (110)	4	BRV
	TD 120	8	120 (47")	115 (250)	2	BRC - BRL - BRT
	TD 170	8	170 (67")	155 (342)	3	BRC - BRL - BRT
	TD 220	8	220 (87")	195 (430)	4	BRC - BRL - BRT
	TD 270	8	270 (106")	240 (529)	5	BRC - BRL - BRT

## BRE 150

150 cm (59")

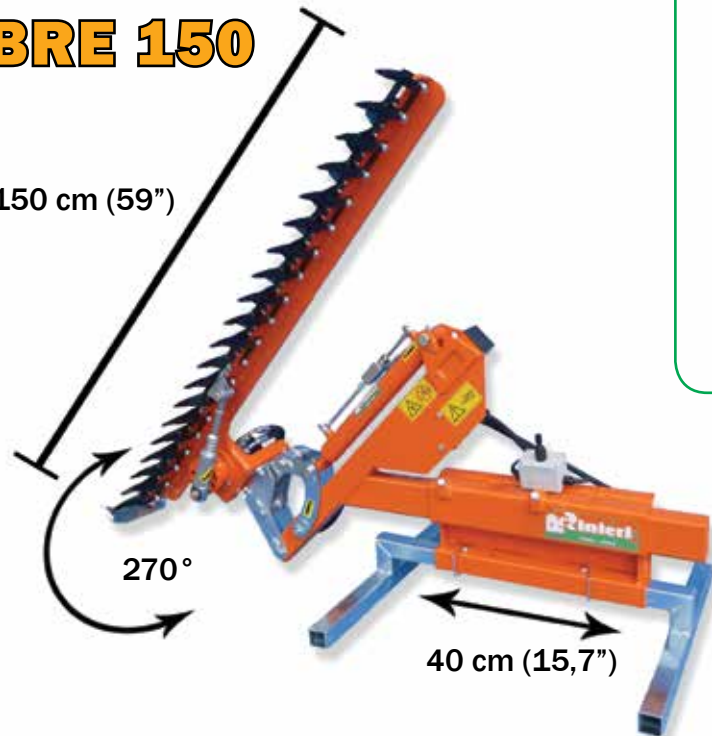

40 cm (15,7")

120 cm  
(47,2")

## BRE 120

270°

40 cm (15,7")



Per mini loader e pale caricatrici.



Suitable for mini-loader and front loader.



Pour mini-chargeurs et chargeurs pour tracteurs.



Für Miniloadler und Baggerschaufeln für Traktoren.



Para mini-carretillas elevadoras y palas cargadoras.



BRM-G 120 completo di attacco per rasaerba. Mantiene tutte le caratteristiche e geometrie di taglio del BRM 120.



BRM-G 120 supplied with attachment support for grass mowers. It has the same capacities and cutting skills as BRM 120.



BRM-G 120 complète d'attelage pour coupe-herbe. Cette machine a les mêmes caractéristiques et capacités de coupe du BRM 120.



BRM-G 120 komplett mit Anschlussstück für Grasmäher. Diese Maschine hat die selben Charakteristika und Schnitteigenschaften wie der BRM 120.



BRM G 120 completo de engancho para cortacespe. Mantiene todas las características y geometrías de corte del BRM 120.

## BRM-G 120



# Rinieri

Via dell'Appennino 606B  
47121 - Forlì (FC) - ITALY  
Tel. +39 0543 86066  
Fax +39 0543 83418

info@rinieri.com

www.rinieri.com